

Project Name:	Type:
Part Number:	Date:



GREENCREATIVE

INNOFIT PLUS SERIES

SPECIFICATION FEATURES

- Mechanical** - The INNOFIT PLUS Downlight is built with a die cast aluminum housing and proprietary integrated IC-rated potted driver providing a great thermal management system to ensure the long life of electronic components. This series is for both new construction and retrofit applications, it can be installed directly into drywall or ceiling grid. Stainless steel spring action clips allow for both easy direct installation from 1/2" to 2" ceiling thicknesses and field accessibility below the ceiling for service or replacement. Post painted in matte white for standard fixture.
- Electrical** - Field select from three lumen outputs using SelectDrive technology. There are 120V ELV/TRIAC Dimming or 0-10V Dimming drivers options for maximum adaptability in any spaces whether it's commercial, residential or mixed. Rated for 120 to 277V, 50/60 Hz the driver is 0-10V dimmable to 5% with low-end cut off. Rated for 120V, the driver is Forward and Reverse phase dimmable down to 10%. Please consult dimmer compatibility for additional information. Sound rating <22db.
- Optical** - Self flanged spun aluminum reflector, painted with high reflection matte white offers a uniform, comfortable appearance. High resistance and non yellowing polycarbonate lens creates a low-glare wide angle light diffusion. Featuring SelectKelvin technology, CCT are adjustable to 3000K/3500K/4000K with switches in the field to meet the requirements of numerous applications. LED binning within 3 SDCM maximum. Offered in minimum 80 CRI. 105° optical wide beam angle standard.
- Thermal** - Die cast heat sink maximizes passive thermal management and achieves a L70 calculated lifetime of 100,000 hours, at 25°C, meeting TM-21-19 requirements. Ambient temperature rated from -13°F to 113°F (-25°C to 45°C). IC installation for IC rated parts limited to ambient temperature +35°C /95.0°F for 4"/6"/8" and +30°C /86.0°F for 9.5".
- Compliance and Warranty** – ETL Classified and Listed for wet location from the bottom once properly installed. Certified air-tight per ASTM 283-04. Complies with FCC 47CFR Part 15B consumer limits for EMI/RFI emissions at 120V. Suitable for use in clothes closets when installed in accordance with the NEC 410.16 spacing requirements. All the items are certified IC for direct contact with insulation. 5 Year Warranty for complete fixture. Optional 10 Year Extended Warranty available, subject to same terms, conditions and installation requirements as standard 5 Year Warranty.

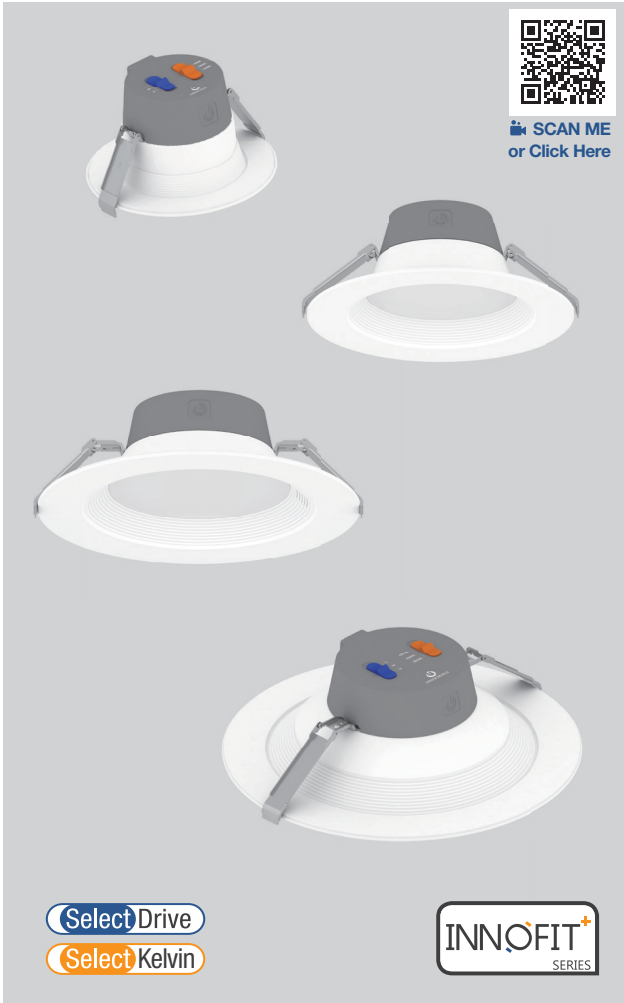

112023



BENEFITS

- Up to 140LPW high light efficacy
- 120V and 0-10V Dimming options provide the easy remodeling, direct mount or retrofitting installation dimming compatibility
- SelectKelvin technology to choose from three color temperatures including 3000K, 3500K, 4000K
- SelectDrive technology allow to select from 3 lumen outputs
- Install virtually anywhere with Wet Location, IC rated models and Air-tight ratings
- Long life time in high ambient temperature range installation

APPLICATIONS

- Commercial
- Retail
- Hospitality
- Education
- Outdoor under covered ceilings



INNOFIT PLUS SERIES

ORDERING INFORMATION

ORDERING EXAMPLE: INFTP6/8CCT3S/DIM010UNV

Model Series	Size	CRI	CCT	Driver
INFTP INNOFIT PLUS Downlight	4 4" 700/1050/1400lm	8 CRI 80+	CCT3S Selectable CCT 3000 / 3500 / 4000K	DIM010UNV 120-277V, 50/60Hz. 0-10V dimming at 120-277V. (Dimmable to 5%)
	6 6" 1180/1700/2100lm			DIM120V¹ 120V, 50/60Hz, Forward/Reverse phase dimming at 120V only. (Dimmable to 10%)
	8 8" 1560/2080/3000lm			
	9.5 9.5" 2100/3150/3650lm			

¹ DIM120V only available in 6" and 8"

LINE DRAWINGS

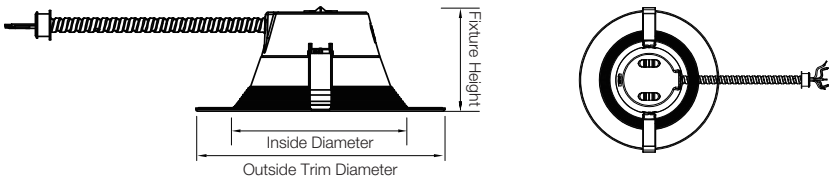

Fixture	Inside Diameter	Outside Trim Diameter	Fixture Height
INFTP4	4-1/16"	5-7/8"	3-7/16"
INFTP6	5-15/16"	8-5/16"	3-7/16"
INFTP8	7-1/2"	10-1/4"	3-7/16"
INFTP9.5	8-7/16"	11-1/4"	3-7/16"

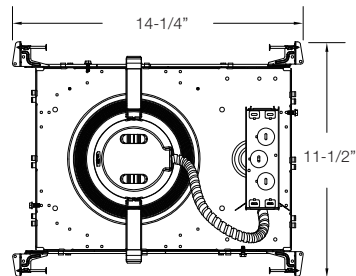
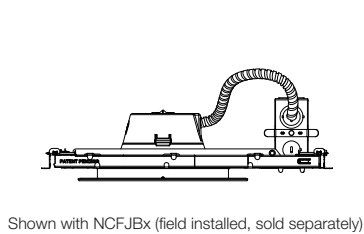

Remodel / Retrofit / Direct Mount Ceiling Cutout			
Type	Minimum	Maximum	
INFTP4/8CCT3S/DIM010UNV	4-1/8"	5-1/8"	
INFTP6/8CCT3S/DIM010UNV	6-1/16"	7-1/2"	
INFTP6/8CCT3S/DIM120V	6-1/16"	7-1/2"	
INFTP8/8CCT3S/DIM010UNV	7-9/16"	9-7/16"	
INFTP8/8CCT3S/DIM120V	7-9/16"	9-7/16"	
INFTP9.5/8CCT3S/DIM010UNV	8-9/16"	10-7/16"	

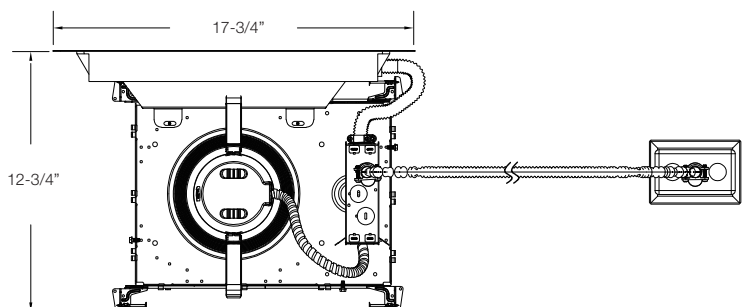
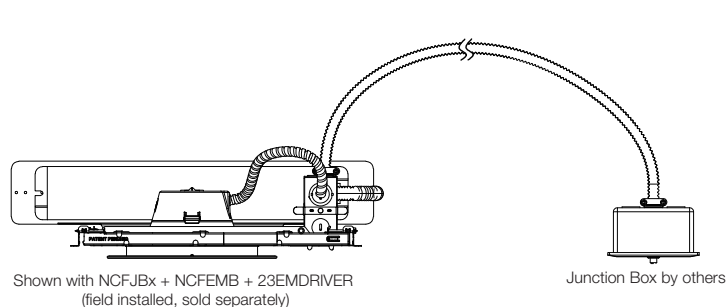



INNOFIT PLUS SERIES

TECHNICAL INFORMATION

Type	Dimming	Input Voltage	Input Frequency	Input Current	Input Power	THD Power	Power Factor	Flicker Index	Sound Rating
4"	0-10V	120-277V	50-60Hz	44mA	6 / 9 / 12W	<20%	>0.9	<30%	<22db
6"	0-10V	120-277V		135mA	9 / 13 / 16W				
8"	0-10V	120-277V		194mA	12 / 16 / 23W				
9.5"	0-10V	120-277V		234mA	16 / 24 / 28W				
6"	ELV/TRIAC	120V		134mA	9 / 13 / 16W				
8"	ELV/TRIAC	120V		192mA	12 / 16 / 23W				

NOMINAL PERFORMANCE











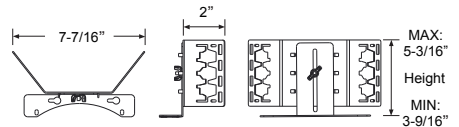

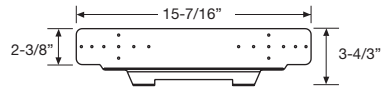
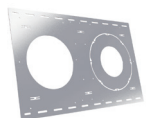
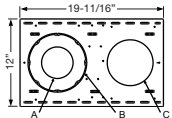
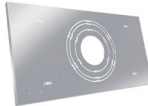
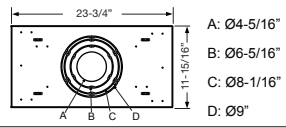
Product	Wattage (W)	3000KCCT / CRI80		3500KCCT / CRI80		4000KCCT / CRI80	
		Lumens (lm)	Efficacy (LPW)	Lumens (lm)	Efficacy (LPW)	Lumens (lm)	Efficacy (LPW)
INFTP4/8CCT3S/DIM010UNV	6	680	113	700	117	700	117
	9	1,015		1,050		1,050	
	12	1,350		1,400		1,400	
INFTP6/8CCT3S/DIM010UNV	9	1,130	126	1,180	131	1,180	131
	13	1,640		1,700		1,700	
	16	2,000		2,100		2,100	
INFTP8/8CCT3S/DIM010UNV	12	1,510	126	1,560	130	1,560	130
	16	2,015		2,080		2,080	
	23	2,900		3,000		3,000	
INFTP9.5/8CCT3S/DIM010UNV	16	2,000	126	2,100	131	2,100	131
	24	3,000		3,150		3,150	
	28	3,500		3,650		3,650	
INFTP6/8CCT3S/DIM120V	9	1,130	126	1,180	131	1,180	131
	13	1,640		1,700		1,700	
	16	2,000		2,100		2,100	
INFTP8/8CCT3S/DIM120V	12	1,510	126	1,560	130	1,560	130
	16	2,015		2,080		2,080	
	23	2,900		3,000		3,000	

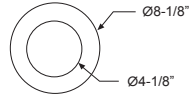
ACCESSORY ORDERING INFORMATION

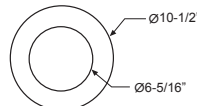
Product	Model	Description	Pictures	Dimensions
35121	NCFJB4	4" New Construction Frame for T-Grid ceilings and stud/joist mounting		
35122	NCFJB6	6" New Construction Frame for T-Grid ceilings and stud/joist mounting		
35123	NCFJB8	8" New Construction Frame for T-Grid ceilings and stud/joist mounting		
35124	NCFJB9.5	9.5" New Construction Frame for T-Grid ceilings and stud/joist mounting		

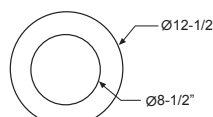

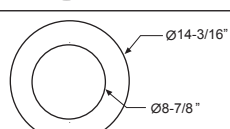
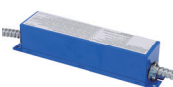
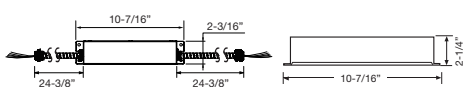
INNOFIT PLUS SERIES

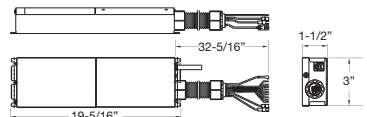
ACCESSORY ORDERING INFORMATION				
Product	Model	Description	Pictures	Dimensions
35126	NCFBFB	Field Installable Butterfly Brackets For New Construction Frame		 <p>7-7/16" (width) 2" (height) MAX: 5-3/16" Height MIN: 3-9/16" Height</p>
35125	NCFEMB	Field Installable Brackets For emergency Driver or Inverter with New Construction Frame		 <p>15-7/16" (length) 2-3/8" (height) 3-4/3" (height)</p>
98502	NCPLATE468	4", 6" and 8" New Construction Plate for Stud/Joist Mounting		 <p>19-11/16" (width) 12" (height) A: Ø4-5/16" B: Ø8-1/16" C: Ø6-5/16"</p>
98501	NCPLATE/T4689	New Construction or Remodel Plate for T-Grid Ceilings		 <p>23-3/4" (width) 11-15/16" (height) A: Ø4-5/16" B: Ø6-5/16" C: Ø8-1/16" D: Ø9"</p>
98569	GOOFRING4	4" Goof Ring - Outer Diameter 8-1/8"		 <p>Ø8-1/8" (outer diameter) Ø4-1/8" (inner diameter)</p>
98568	GOOFRING6	6" Goof Ring - Outer Diameter 10-1/2"		 <p>Ø10-1/2" (outer diameter) Ø6-5/16" (inner diameter)</p>
98567	GOOFRING8	8" Goof Ring - Outer Diameter 12-1/2"		 <p>Ø12-1/2" (outer diameter) Ø8-1/2" (inner diameter)</p>
98566	GOOFRING9.5	9.5" Goof Ring - Outer Diameter 14-3/16"		 <p>Ø14-3/16" (outer diameter) Ø8-7/8" (inner diameter)</p>
98003	23EMDRIVER	California Title 20 Compliant 23W Emergency LED Driver for field installation. Not compatible with 9.5" models.		 <p>10-7/16" (length) 2-3/16" (width) 24-3/8" (length) 24-3/8" (length) 10-7/16" (length) 2-1/4" (height)</p>
FHUPS1-UNV-25L-SD	FHUPS1-UNV-25L-SD	25W Emergency Micro Inverter for field installation to use with 0-10V Driver options. 100-277VAC (up to 150W with use of 0-10V dimming). CEC Compliant		 <p>1-1/2" (width) 32-5/16" (length) 19-5/16" (length) 3" (height)</p>



INNOFIT PLUS SERIES

ORDERING GUIDE

Product	Model	Case Quantity
36994	INFTP4/8CCT3S/DIM010UNV	6pcs
36995	INFTP6/8CCT3S/DIM010UNV	6pcs
36996	INFTP8/8CCT3S/DIM010UNV	6pcs
36997	INFTP9.5/8CCT3S/DIM010UNV	6pcs
36991	INFTP6/8CCT3S/DIM120V	6pcs
36992	INFTP8/8CCT3S/DIM120V	6pcs

CERTIFICATION INFORMATION

Product	Model	ES ID#
36991	INFTP6/8CCT3S/DIM120V	2456040
36992	INFTP8/8CCT3S/DIM120V	2453283
36994	INFTP4/8CCT3S/DIM010UNV	2453211
36995	INFTP6/8CCT3S/DIM010UNV	2467215
36996	INFTP8/8CCT3S/DIM010UNV	2467427
36997	INFTP9.5/8CCT3S/DIM010UNV	2467575



INNOFIT PLUS SERIES

PHOTOMETRY

INFTP4/8CCT3S/DIM010UNV (at 3500K)

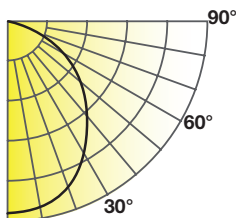

Lumens: 1,352 lm
 CBCP: 631 cd
 Power: 12 W
 Efficacy: 120 lm/W
 CRI: 80
 Spacing Criteria: 1.2
 Beam Angle: 93°

Candlepower Distribution		Initial Footcandles			Zonal Lumen Summary		
Angle (°)	Average (cd)	Height (ft)	Fc	Diameter (ft)	Zone	Lumens	%Fixt
10	602	8	10	17	0-30	468	35
20	561	10	6	21	0-40	742	55
30	487	12	4	25	0-60	1,191	88
40	387	15	3	32	0-90	1,350	100
50	278	20	2	42			
60	163						
70	72						
80	15						
90	0						

INFTP6/8CCT3S/DIM010UNV (at 3500K)

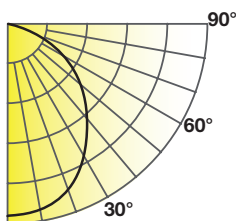

Lumens: 2,078 lm
 CBCP: 882 cd
 Power: 16 W
 Efficacy: 137 lm/W
 CRI: 80
 Spacing Criteria: 1.2
 Beam Angle: 101°

Candlepower Distribution		Initial Footcandles			Zonal Lumen Summary		
Angle (°)	Average (cd)	Height (ft)	Fc	Diameter (ft)	Zone	Lumens	%Fixt
10	851	8	14	19	0-30	660	32
20	792	10	9	24	0-40	1,062	51
30	700	12	6	29	0-60	1,787	86
40	580	15	4	36	0-90	2,075	100
50	444	20	2	48			
60	283						
70	132						
80	19						
90	0						

INFTP8/8CCT3S/DIM010UNV (at 3500K)

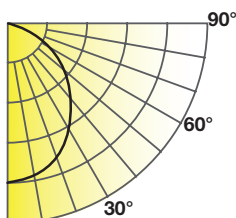

Lumens: 3,026 lm
 CBCP: 1,191 cd
 Power: 24 W
 Efficacy: 141 lm/W
 CRI: 80
 Spacing Criteria: 1.2
 Beam Angle: 106°

Candlepower Distribution		Initial Footcandles			Zonal Lumen Summary		
Angle (°)	Average (cd)	Height (ft)	Fc	Diameter (ft)	Zone	Lumens	%Fixt
10	1,147	8	19	21	0-30	895	30
20	1,071	10	12	27	0-40	1,149	48
30	954	12	8	32	0-60	2,506	83
40	812	15	5	40	0-90	3,021	100
50	645	20	3	53			
60	457						
70	200						
80	47						
90	0						



INNOFIT PLUS SERIES

PHOTOMETRY

INFTP9.5/8CCT3S/DIM010UNV (at 3500K)

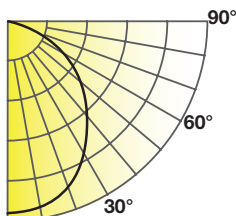

Lumens: 3,771 lm
 CBCP: 1,467 cd
 Power: 28 W
 Efficacy: 143 lm/W
 CRI: 80
 Spacing Criteria: 1.2
 Beam Angle: 107°

Candlepower Distribution		Initial Footcandles			Zonal Lumen Summary		
Angle (°)	Average (cd)	Height (ft)	Fc	Diameter (ft)	Zone	Lumens	%Fixt
10	1,417	8	23	21	0-30	1,105	29
20	1,324	10	15	27	0-40	1,790	48
30	1,184	12	10	32	0-60	3,097	82
40	1,004	15	7	40	0-90	3,764	100
50	796	20	4	54			
60	569						
70	321						
80	77						
90	0						

INFTP6/8CCT3S/DIM120V (at 3500K)

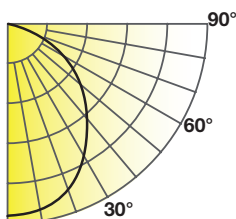

Lumens: 2,023 lm
 CBCP: 857 cd
 Power: 16 W
 Efficacy: 132 lm/W
 CRI: 80
 Spacing Criteria: 1.2
 Beam Angle: 101°

Candlepower Distribution		Initial Footcandles			Zonal Lumen Summary		
Angle (°)	Average (cd)	Height (ft)	Fc	Diameter (ft)	Zone	Lumens	%Fixt
10	826	8	13	19	0-30	641	32
20	769	10	9	24	0-40	1,032	51
30	780	12	6	29	0-60	1,738	86
40	566	15	4	37	0-90	2,020	100
50	433	20	2	49			
60	281						
70	131						
80	19						
90	0						

INFTP8/8CCT3S/DIM120V (at 3500K)

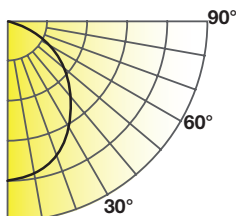

Lumens: 2,907 lm
 CBCP: 1,136 cd
 Power: 24 W
 Efficacy: 128 lm/W
 CRI: 80
 Spacing Criteria: 1.2
 Beam Angle: 106°

Candlepower Distribution		Initial Footcandles			Zonal Lumen Summary		
Angle (°)	Average (cd)	Height (ft)	Fc	Diameter (ft)	Zone	Lumens	%Fixt
10	1,101	8	18	19	0-30	860	30
20	1,027	10	11	24	0-40	1,393	48
30	926	12	8	29	0-60	2,408	83
40	781	15	5	37	0-90	2,902	100
50	619	20	3	49			
60	438						
70	240						
80	48						
90	0						

Note: All rights reserved. All sizes and specifications are subject to change at any time without notice.