

Project Name:	Type:
Part Number:	Date:

8" INNOFIT GEN 2 COMMERCIAL DOWNLIGHT

SPECIFICATION FEATURES

- **Mechanical** - INNOFIT, with integrated driver, retrofits existing commercial housings and is field accessible from below the ceiling. Stainless steel spring action clips accommodate ½" to 2" ceiling thicknesses. Optional New Construction housing available.
- **Electrical** - Field select from three lumen outputs using SelectDrive technology. Universal 120-277V or 120V only, 50/60 Hz drivers available. Universal 0-10V drivers are dimmable to 5% with low end cutoff. 120V drivers are dimmable to 10% using forward or reverse phase dimmers.
- **Optical** - Self flanged, spun aluminum reflector with baffle trim for pleasant aesthetic in matte white finish. High resistance polycarbonate optical lens, with smooth diffusion. 110° beam angle. LED binned to 3-step SDCM to ensure color uniformity in 2700K, 3000K, 3500K, 4000K or 5000K CCT, with Minimum 80 CRI.
- **Thermal** - Fixture designed using passive thermal management to achieve a L70 rating of 50,000 hours.
Fixture operating temperature: -13°F to 95°F (-25°C to 35°C).
- **Compliance and Warranty** - ETL Classified and Listed for wet locations. Certified air-tight per ASTM 283-04. IC Rated for direct contact with insulation. Complies with FCC 47CFR Part 15B consumer limits for EMI/RFI emissions. 5 year parts warranty for complete fixture. Optional 10 Year Extended Warranty available, subject to same terms, conditions and installation requirements as standard 5 Year Warranty.



BENEFITS

- Field select lumen output
- Quick and easy installation
- 0-10V or 120V dimmable
- Wet Location, IC and Airtight Rated
- Long life time, L70 Rated for 50,000 hours

APPLICATIONS

- New and retrofit construction
- Shallow plenum applications
- Commercial
- Retail & Office
- Education and Hospitality

ORDERING INFORMATION

Series	Size	CRI	CCT	Dimming
<input checked="" type="checkbox"/> INFT INNOFIT	<input checked="" type="checkbox"/> 8 8" 1,100 / 1,600 / 2,100 lumens	<input checked="" type="checkbox"/> 8 CRI 80	<input type="checkbox"/> 27 2700K	<input type="checkbox"/> DIM010UNV 120-277V, 0-10V (Dimmable to 5%)
			<input type="checkbox"/> 30 3000K	
			<input type="checkbox"/> 35 3500K	
			<input type="checkbox"/> 40 4000K	
			<input type="checkbox"/> 50 5000K	



8" INNOFIT GEN 2 COMMERCIAL DOWNLIGHT

LINE DRAWINGS

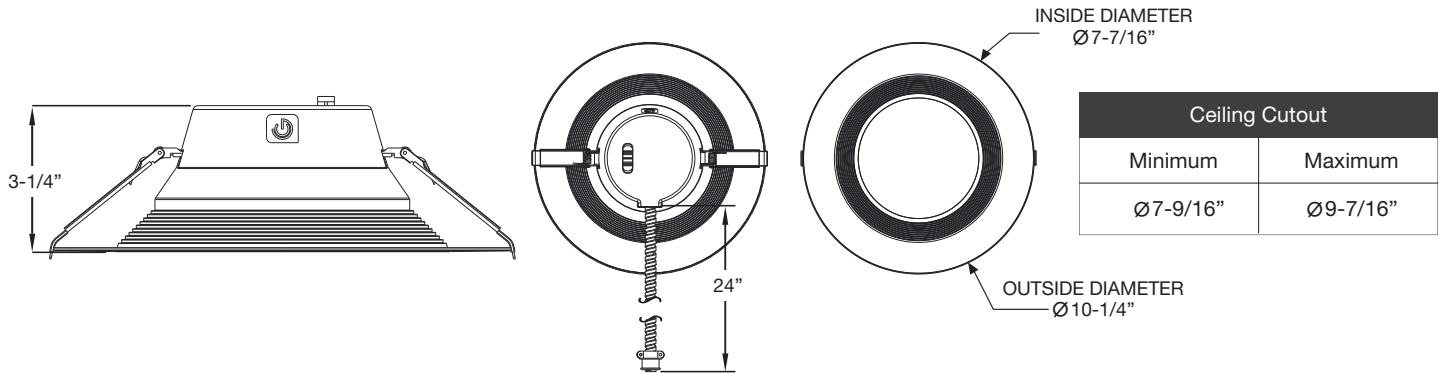

TECHNICAL INFORMATION

Dimming	Input Voltage	Input Frequency	Input Current (Low / Med / High)	Input Power	THD Power	Power Factor
DIM120V	120V	50 / 60Hz	0.078 / 0.1 / 0.145A	8.5 / 12 / 17W	<20%	>0.9
DIM010VUNV	120V	50 / 60Hz	0.07 / 0.1 / 0.145A	8.5 / 12 / 17W	<20%	>0.9
	277V		0.045 / 0.06 / 0.078A			

PHOTOMETRY

INFT8/835/DIM010UNV (HIGH OUTPUT)

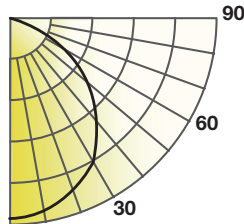

Lumens: 2,296 lm
 CBCP: 898 cd
 Power: 17.6 W
 Efficacy: 130 lm/W
 CRI: 80+
 Spacing Criteria: 1.22
 Beam Angle: 106.5°

Candlepower Distribution	
Angle (°)	Average (cd)
0	989
5	893
15	851
25	788
35	689
45	571
55	434
65	270
75	109
85	7
90	0

Initial Footcandles		
Height (ft)	Fc	Diameter (ft)
8	23	21.4
9	18	24.1
10	15	26.8
12	10	32.1
15	7	40.2







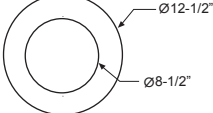

Zonal Lumen Summary		
Zone	Lumens	%Fixture
0-30	686	30%
0-40	1,112	48%
0-60	1,922	84%
0-90	2,296	100%

PERFORMANCE

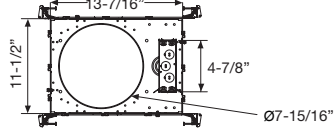
CCT	2700K			3000K			3500K			4000K			5000K		
	Low	Med	High	Low	Med	High	Low	Med	High	Low	Med	High	Low	Med	High
Output	1,000	1,415	2,000	1,030	1,450	2,060	1,045	1,475	2,090	1,060	1,500	2,125	1,060	1,500	2,125
LPW	118	118	118	121	121	121	123	123	123	125	125	125	125	125	125

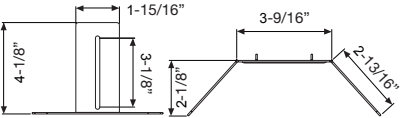

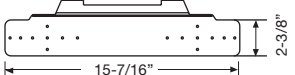
8" INNOFIT GEN 2 COMMERCIAL DOWNLIGHT

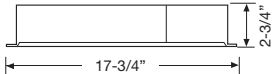
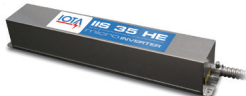
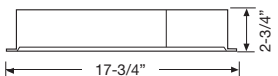
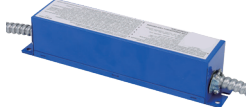
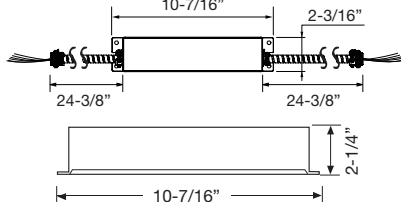
ACCESSORY ORDERING INFORMATION				
Product	Model	Description	Pictures	Dimensions
98567	GOOFRING8	8" Goof Ring - Outer Diameter 12-1/2"		
35123	NCFJB8	8" Round New Construction Rough-in Frame with Jbox		
35126	NCFBFB	Field Installable Butterfly Brackets For New Construction Rough-in Frame		
35125	NCFEMB	Field Installable Emergency Bracket For New Construction Rough-in Frame		
58012	35EMINVERTER	35W Emergency Inverter (Field Installation)		
58013	35EMINVERTER/CEC	California Title 20 Compliant 35W Emergency Inverter (Field Installation)		
98003	23EMDRIVER	California Title 20 Compliant 23W Emergency LED Driver (Field Installation)		

10 YEAR EXTENDED WARRANTY	
Model	INFT8/10YEARWARRANTY