

Project Name:	Type:
Part Number:	Date:

9.5" INNOFIT GEN 2 COMMERCIAL DOWNLIGHT

SPECIFICATION FEATURES

- **Mechanical** - INNOFIT, with integrated driver, retrofits existing commercial housings and is field accessible from below the ceiling. Stainless steel spring action clips accommodate 1/2" to 2" ceiling thicknesses. Optional New Construction housing available.
- **Electrical** - Field select from three lumen outputs using SelectDrive technology. Universal 120-277V or 120V only, 50/60 Hz drivers available. Universal 0-10V drivers are dimmable to 5% with low end cutoff. 120V drivers are dimmable to 10% using forward or reverse phase dimmers.
- **Optical** - Self flanged, spun aluminum reflector with baffle trim for pleasant aesthetic in matte white finish. High resistance polycarbonate optical lens, with smooth diffusion. 110° beam angle. LED binned to 3-step SDCM to ensure color uniformity in 2700K, 3000K, 3500K, 4000K or 5000K CCT, with Minimum 80 CRI.
- **Thermal** - Fixture designed using passive thermal management to achieve a L70 rating of 50,000 hours. Fixture operating temperature: -13°F to 95°F (-25°C to 35°C).
- **Compliance and Warranty** - ETL Classified and Listed for wet locations. Certified air-tight per ASTM 283-04. IC Rated for direct contact with insulation. Complies with FCC 47CFR Part 15B consumer limits for EMI/RFI emissions. 5 year parts warranty for complete fixture. Optional 10 Year Extended Warranty available, subject to same terms, conditions and installation requirements as standard 5 Year Warranty.



BENEFITS

- Field select lumen output
- Quick and easy installation
- 0-10V or 120V dimmable
- Wet Location, IC and Airtight Rated
- Long life time, L70 Rated for 50,000 hours

APPLICATIONS

- New and retrofit construction
- Shallow plenum applications
- Commercial
- Retail & Office
- Education and Hospitality

ORDERING INFORMATION

Series	Size	CRI	CCT	Dimming
<input checked="" type="checkbox"/> INFT INNOFIT	<input checked="" type="checkbox"/> 9.5 9.5" 2,100 / 2,600 / 3,500 lumens	<input checked="" type="checkbox"/> 8 CRI 80	<input type="checkbox"/> 27 2700K	<input type="checkbox"/> DIM010UNV 120-277V, 0-10V (Dimmable to 5%)
			<input type="checkbox"/> 30 3000K	
			<input type="checkbox"/> 35 3500K	
			<input type="checkbox"/> 40 4000K	
			<input type="checkbox"/> 50 5000K	



9.5" INNOFIT GEN 2 COMMERCIAL DOWNLIGHT

LINE DRAWINGS

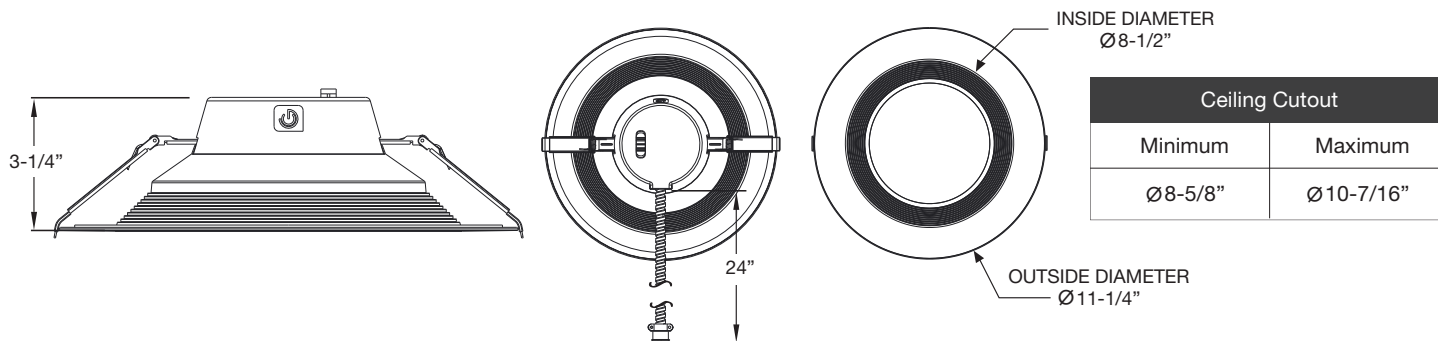

TECHNICAL INFORMATION

Dimming	Input Voltage	Input Frequency	Input Current (Low / Med / High)	Input Power	THD Power	Power Factor
DIM120V	120V	50 / 60Hz	0.145/0.18/0.235A	17/ 21 / 27W	<20%	>0.9
DIM010VUNV	120V	50 / 60Hz	0.145/0.18/0.235A	17/ 21 / 27W	<20%	>0.9
	277V		0.082/0.095/0.115A			

PHOTOMETRY

INFT9.5/835/DIM010UNV (HIGH OUTPUT)

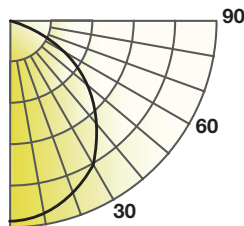

Lumens: 3,595 lm
 CBCP: 1,358 cd
 Power: 26.6 W
 Efficacy: 135 lm/W
 CRI: 80+
 Spacing Criteria: 1.23
 Beam Angle: 108.4°

Candlepower Distribution	
Angle (°)	Average (cd)
0	1,358
5	1,351
15	1,294
25	1,187
35	1,041
45	862
55	654
65	423
75	172
85	10
90	0

Initial Footcandles		
Height (ft)	Fc	Diameter (ft)
8	32	22.2
9	25	25.0
10	20	27.7
12	14	33.3
15	9	41.6







Zonal Lumen Summary		
Zone	Lumens	%Fixture
0-30	1,042	29%
0-40	1,694	47%
0-60	2,954	82%
0-90	3,595	100%

PERFORMANCE

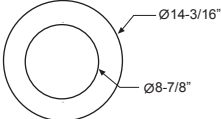
CCT	2700K			3000K			3500K			4000K			5000K		
	Low	Med	High	Low	Med	High	Low	Med	High	Low	Med	High	Low	Med	High
Output	Low	Med	High	Low	Med	High	Low	Med	High	Low	Med	High	Low	Med	High
Lumens	2,040	2,520	3,240	2,090	2,585	3,320	2,125	2,625	3,375	2,160	2,665	3,430	2,160	2665	3,430
LPW	120	120	120	123	123	123	125	125	125	127	127	127	127	127	127



9.5" INNOFIT GEN 2 COMMERCIAL DOWNLIGHT

ACCESSORY ORDERING INFORMATION				
Product	Model	Description	Pictures	Dimensions
98566	GOOFRING9.5	9.5" Goof Ring - Outer Diameter 14-3/16"		
35124	NCFJB9.5	9.5" Round New Construction Rough-in Frame with Jbox		
35126	NCFBFB	Field Installable Butterfly Brackets For New Construction Rough-in Frame		
35125	NCFEMB	Field Installable Emergency Bracket For New Construction Rough-in Frame		
58012	35EMINVERTER	35W Emergency Inverter (Field Installation)		
58013	35EMINVERTER/CEC	California Title 20 Compliant 35W Emergency Inverter (Field Installation)		

10 YEAR EXTENDED WARRANTY	
Model	INFT9.5/10YEARWARRANTY