

Project Name:	Type:
Part Number:	Date:

DOUBLE ENDED BYPASS T8 8FT

FEATURES

- Integral driver suitable for 120-277V
- Replaces 8ft F96T8 / F96T12 Fluorescent lamps
- Available in Single pin (Fa8) & Recessed Double Contact pin (R17d)
- Double ended installation, no need to change existing sockets
- Opaque glass design eliminates pixilation and reduces glare
- High performance, lumen output up to 5,500lm, 137.5LPW
- 310° wide light emitting area
- Suitable for enclosed fixtures
- NSF (National Sanitation Foundation) certified for Food Zone (Non-Contact), Splash, and Non-Food Zones
- UL 1598C classified
- Temperature rating: -4°F/20°C – 113°F/45°C
- Rated lifetime (L70): 50,000hrs
- 5 year limited warranty* / 10 year available (see EXTENDED WARRANTIES table for information)
- Suitable for all indoor general lighting applications and damp locations

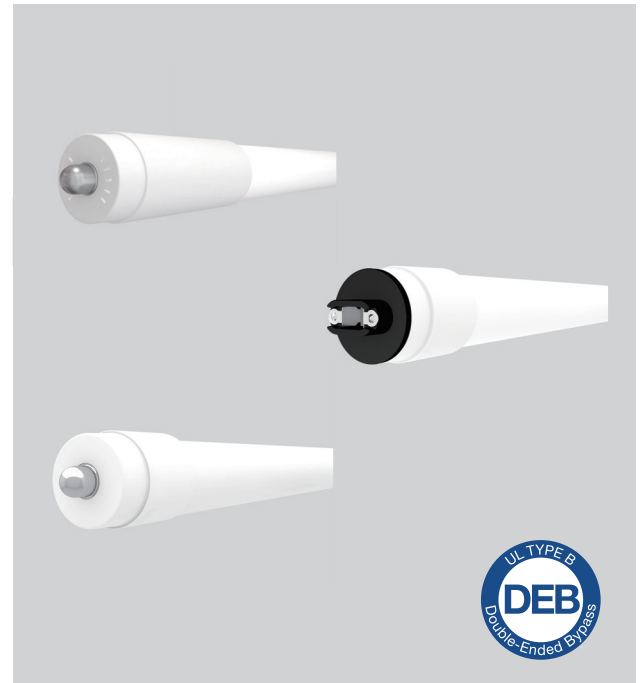

041024



SPECIFICATIONS

Product	Model	Equiv.	Input Voltage	Wattage	Lumens	CCT	CRI	Efficacy (LPW)	Power Factor	THD	Beam Angle	Fixture Rating	DLC / NSF
36766	40T8/8F/840/DEB/Fa8	F96T8 F96T12	120-277V	40	5,500	4000K	82	137.5	0.9	<20%	160°	Enclosed	√/√
36767	40T8/8F/850/DEB/Fa8	F96T8 F96T12	120-277V	40	5,500	5000K	82	137.5	0.9	<20%	160°	Enclosed	√/√
34870	43T8/8F/850/DEB/Fa8	F96T8 F96T12	120-277V	43	5,500	5000K	82	128	0.9	<20%	160°	Enclosed	N.A. / √
34871	43T8/8F/840/DEB/R17d	F96T8 F96T12	120-277V	43	5,500	4000K	82	128	0.9	<20%	160°	Enclosed	N.A. / √
36769	40T8/8F/850/DEB/R17d	F96T8 F96T12	120-277V	40	5,500	5000K	82	137.5	0.9	<20%	160°	Enclosed	N.A. / √

* Please visit www.greencreative.com for Limited Warranty terms.

SUPPLIED ACCESSORY

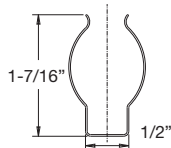
Product	Model	Description	Picture	Dimension	Weight
34873	T8CLIP	Kit including self-tapping screw and support clip (Clip x 1, ST4.2 hexagon washer head self drilling screw x 1)			0.2oz

DIMENSION & WEIGHT

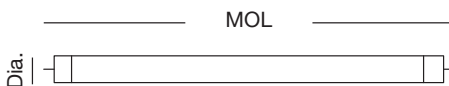

Model	43T8/8F/xxx/DEB/Fa8	43T8/8F/xxx/DEB/R17d	40T8/8F/xxx/DEB/Fa8	40T8/8F/xxx/DEB/R17d
Base	Fa8 (Single Pin)	R17d (Recessed Double Contact)	Fa8 (Single Pin)	Fa8 (Single Pin)
MOL	93-15/16"	93-15/16"	94"	94"
Dia.	1-15/16"	1-15/16"	1-1/16"	1-1/16"
Weight	0.92lb	0.92lb	0.88lb	0.88lb

Where xxx means 824-965 which indicates CRI and color temperature



DOUBLE ENDED BYPASS T8 8FT

INSTALLATION

Fa8 - SINGLE PIN 1 LAMP

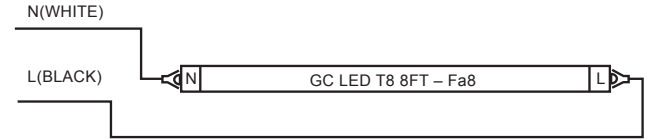
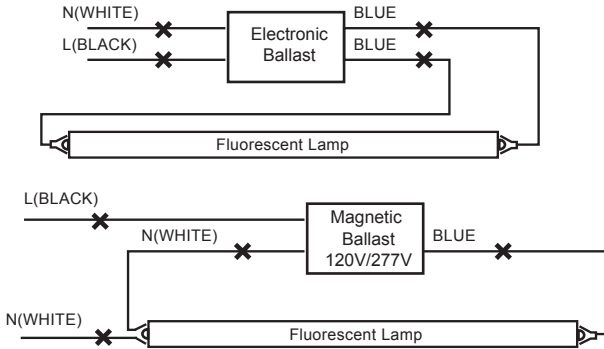

Step 1. Cut all wires connected to the existing ballast, remove the ballast

Step 2. Wire the holders and lamps according to the above diagram

PIN R17d – Recessed Double Contact 1 LAMP

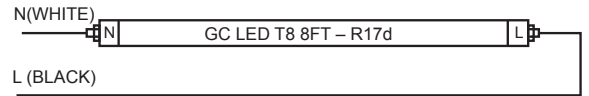
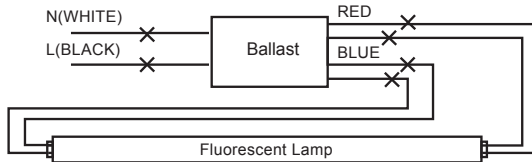

Step 1. Cut all wires connected to the existing ballast, remove the ballast

Step 2. Wire the holders and lamps according to the above diagram

ACCESSORY ORDERING INFORMATION

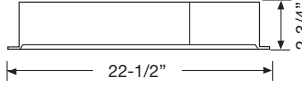
Product	Model	Description	Picture	Dimension	Weight
98235	50EMINVERTER	Emergency Inverter 50W			9.0lb

- Fixtures must be installed within 250' of inverter
- UL 924 listed for field installation
- Suitable for damp locations
- Galvanized steel enclosure with 36" conduit for wiring connections to the fixture
- Includes test switch and charge indicator accessory kit
- Replaceable and recyclable long-life high temperature nickel-cadmium battery

EXTENDED WARRANTIES***

Model	Description****
43T8/8F/DEB/10YEARWARRANTY	10 Year warranty for 43T8/8F/8xx/DEB/xxxx/yy
40T8/8F/DEB/10YEARWARRANTY	10 Year warranty for 40T8/8F/8xx/DEB/xxxx/yy

*** Warranty based on a maximum of 4,368 annual operating hours (per year for ten years) and exposure to a maximum ambient temperature of 80°F / 27°C.

**** xx – Refers to the CCT yy – Refers to model generations within the same nominal performance. Typically blank, 'R', or 'RC'

Where xxxx means Fa8 or R17d base



DOUBLE ENDED BYPASS T8 8FT

CERTIFICATION INFORMATION

Product	Model	DLC ID#
36766	40T8/8F/840/DEB/Fa8	PL13PDEAFT5Q
36767	40T8/8F/850/DEB/Fa8	PLM8JGZA2JLE

ORDERING INFORMATION

Model	Master Carton			Shipping Carton		
	Case Qty	Case Dimensions (LxWxH)	Case Weight	Case Qty	Case Dimensions (LxWxH)	Case Weight
43T8/8F/xxx/DEB/Fa8	NA	NA	NA	10PCS	95-13/16" x 7-1/2" x 3-7/8"	11.75 lb
43T8/8F/xxx/DEB/R17d	NA	NA	NA	10PCS	95-13/16" x 7-1/2" x 3-7/8"	11.75 lb
40T8/8F/xxx/DEB/Fa8	NA	NA	NA	10PCS	95-13/16" x 7-1/2" x 3-7/8"	11.75 lb
40T8/8F/xxx/DEB/R17d	NA	NA	NA	10PCS	95-13/16" x 7-1/2" x 3-7/8"	11.75 lb

Where xxx means 824-965 which indicates CRI and color temperature

Note: All rights reserved. All sizes and specifications are subject to change at any time without notice.