

SELECTFIT DUALDIM DOWNLIGHT INSTALLATION GUIDE - WARNING

WARNING – READ ALL PRODUCT LABELS AND INSTRUCTIONS BEFORE INSTALLING FIXTURE. LIRE TOUTES LES ETIQUETTES ET LES INSTRUCTIONS AVANT DE PROCEDER A L'INSTALLATION.

WARNING – THE FIXTURE IS INTENDED FOR MOUNTING ONLY IN A COVERED CEILING WHERE ONLY THE LED SIDE OF THE LUMINAIRE WILL BE EXPOSED TO WET LOCATION. LE LUMINAIRE EST PREVU POUR ETRE INSTALLER DANS UN PLAFOND COUVERT, OU SEUL LA FACE AVEC LES LEDS PEUT ETRE EXPOSE A UN ENVIRONNEMENT MOUILLE.

WARNING – INSTALLATION SHOULD ONLY BE PERFORMED AFTER POWER TO THE FIXTURE HAS BEEN L'INSTALLATION DU LUMINAIRE DOIT ETRE FAITE UNE FOIS LE COURANT MIS HORS TENSION.

WARNING – RISK OF FIRE OR ELECTRIC SHOCK. INSTALLATION OF THIS RETROFIT KIT REQUIRES A PERSON FAMILIAR WITH THE CONSTRUCTION AND OPERATION OF THE LUMINAIRE'S ELECTRICAL SYSTEM AND THE HAZARD INVOLVED. IF NOT QUALIFIED, DO NOT ATTEMPT INSTALLATION. CONTACT A QUALIFIED ELECTRICIAN. AVERTISSEMENT - RISQUE D'INCENDIE OU DE CHOC ELECTRIQUE. L'INSTALLATION DE CE NECESSAIRE DE MODERNISATION EXIGE UNE PERSONNE FAMILIERE AVEC LA CONSTRUCTION ET LE FONCTIONNEMENT DU SYSTEME ELECTRIQUE DU LUMINAIRE ET DES RISQUES ASSOCIES. TOUTE PERSONNE QUI N'EST PAS QUALIFIEE NE DOIT FAIRE AUCUNE TENTATIVE D'INSTALLATION ET DOIT CONTACTER UN ELECTRICIEN QUALIFIE.

WARNING – RISK OF FIRE OR ELECTRIC SHOCK. INSTALL THIS KIT ONLY IN THE LUMINAIRE THAT HAS THE CONSTRUCTION FEATURES AND DIMENSIONS SHOWN IN THE PHOTOGRAPHS AND/OR DRAWINGS AND WHERE THE INPUT RATING OF THE RETROFIT KIT DOES NOT EXCEED THE INPUT RATING OF THE LUMINAIRE. AVERTISSEMENT - RISQUE D'INCENDIE OU DE CHOC ELECTRIQUE. N'INSTALLER CE NECESSAIRE QUE DANS LE LUMINAIRE DONT LES CARACTERISTIQUES DE CONSTRUCTION ET LES DIMENSIONS SONT MONTREES DANS LES DESSINS ET PHOTOS, ET OU LE COURANT D'ENTREE DU LUMINAIRE NE DEPASSE PAS LE COURANT MAXIMUM INDIQUE.

DO NOT MAKE OR ALTER ANY OPEN HOLES IN AN ENCLOSURE OF WIRING OR ELECTRICAL COMPONENTS DURING KIT INSTALLATION. IL EST INTERDIT DE FAIRE OU DE MODIFIER UNE OUVERTURE DANS UN BOITIER DE CABLAGE OU DE COMPOSANTS ELECTRIQUES AU COURS DE L'INSTALLATION DU NECESSAIRE.

WARNING – TO PREVENT WIRING DAMAGE OR ABRASION, DO NOT EXPOSE WIRING TO EDGES OF SHEET METAL OR OTHER SHARP OBJECTS. AVERTISSEMENT - AFIN DE PREVENIR L'ENDOMMAGEMENT OU L'ABRASION DES CABLES, EVITER TOUT CONTACT ENTRE CES CABLES ET LES BORDURES DES TOLES OU TOUT AUTRES OBJETS TRANCHANT

WIRING DIAGRAM

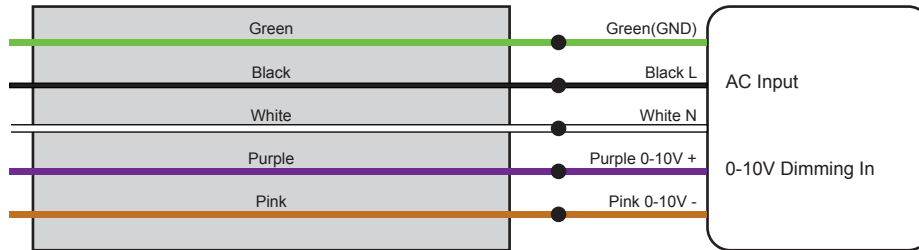

1. For not dimmable or forward & reverse phase dimming, use only black (L), white (N) & Green (GND).
2. Don't use 0-10V and Forward & Reverse Phase dimming together.

RETROFIT INSTALLATION

NOTE: This product is not intended for retrofitting Insulation-Contact enclosures. The enclosure would need to be removed before installation of this luminaire.

1. Make sure the POWER IS TURNED OFF at the source before retrofitting the luminaire.
2. If accessories are needed please go see appropriate accessories installation, in the accessory section (p. 3)
3. If existing lamp and trim are present, remove from ceiling or move it out of the way as it will not be needed during installation.(fig.1) Measure the ceiling opening to make sure the edge of the luminaire will cover the entire hole and still sit firmly in the ceiling before proceeding. See dimension tables for more information.
4. Attach the carabiner safety clip to the existing mounting plate.(fig. 2)
5. Remove J-box faceplate. Disconnect all wires to the ballast and remove ballast from J-Box. Remove appropriate round knock out and attach the fixture conduit whip into knock out. Follow wiring diagram for connection, using the provided connectors. Reattach J-box faceplate. (fig. 3)
6. Adjust the fixture power to desired lumen output by sliding the blue selector switch. Adjust the color temperature to desired one, by sliding the orange selector switch. Make sure the switch is never in between positions. (fig. 4)
7. Squeeze the two spring clips so they are in an upright position and insert lamp into mounting plate. (fig. 5)
8. Once fixture is inside the plate, release the spring clips and continue pushing fixture until securely fixed and flush with ceiling. (fig. 6)
9. Restore power at the source and the installation is complete.

fig. 1

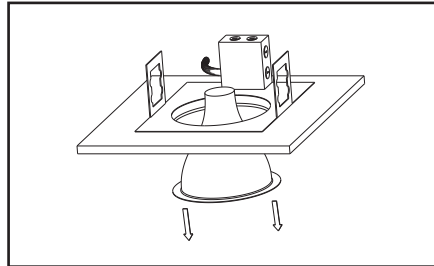

fig. 2

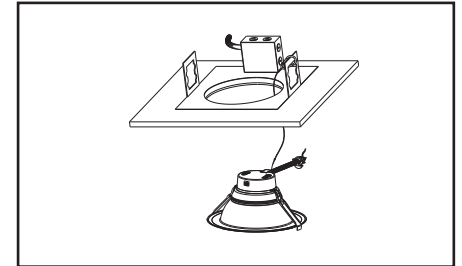

fig. 3

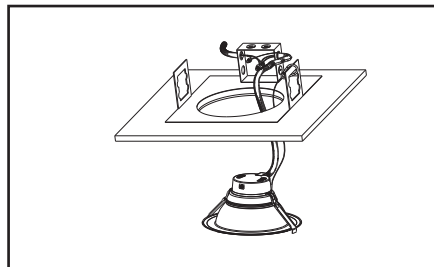

fig. 4

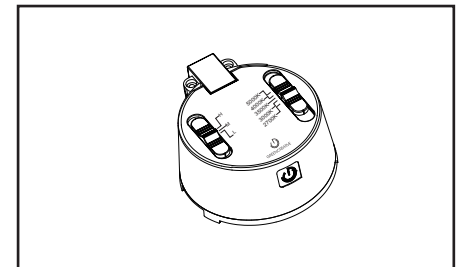

fig. 5

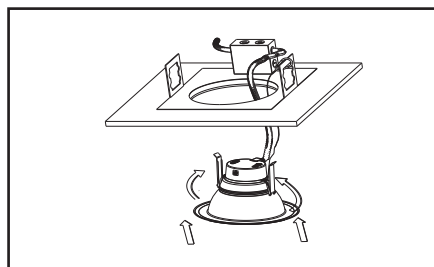
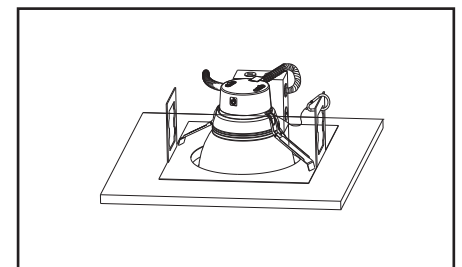

fig. 6



DIRECT MOUNT AND NEW CONSTRUCTION INSTALLATION

1. Make sure the POWER IS TURNED OFF at the source to the location in which you are installing the product.
2. If accessories are needed please go see appropriate accessories installation, in the accessory section (p. 3)
3. If using a new Construction Plate, install it in the ceiling following its own installation instruction. (fig. 1)
4. If a new hole is needed, use a hole cutter and set the diameter according to the dimensional table, or cut along the edge of the new construction plate prepared for the desired size (fig. 2).
5. Attach the carabiner safety clip to a secure place inside the ceiling. (fig. 3)
6. Adjust the fixture power to desired lumen output by sliding the blue selector switch. Adjust the color temperature to desired one, by sliding the orange selector switch. Make sure the switch is never in between positions. (fig. 4)
7. Insert luminaire conduit into a preinstalled J-box by other or into the New Construction Frame J-box. and wire to the power source following wiring diagram (p. 1). Squeeze the two spring clips so they are in an upright position and insert lamp in the ceiling. (fig. 5)
8. Once lamp is inside the ceiling, release the spring clips and continue pushing fixture until securely fixed and flush with ceiling. (fig. 6)
9. Restore power at the source and the installation is complete.

fig. 1

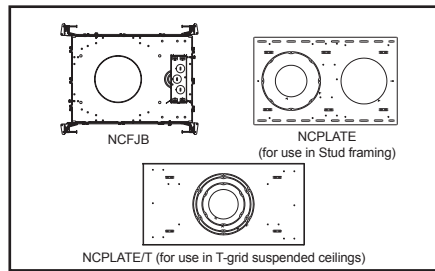

fig. 2

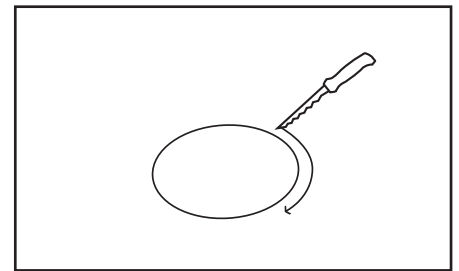

fig. 3

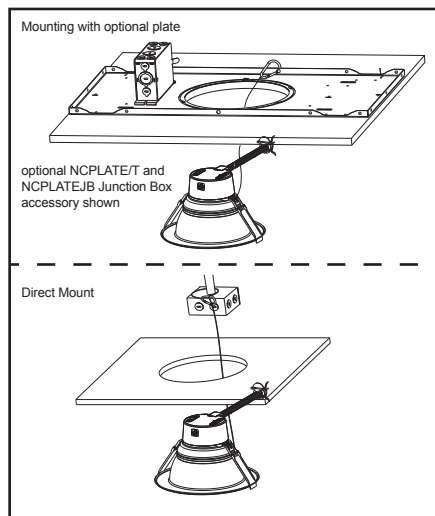

fig. 4

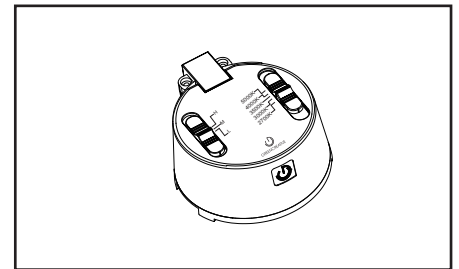

fig. 6

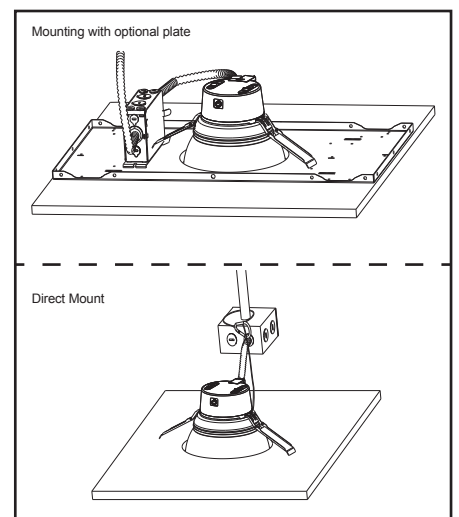
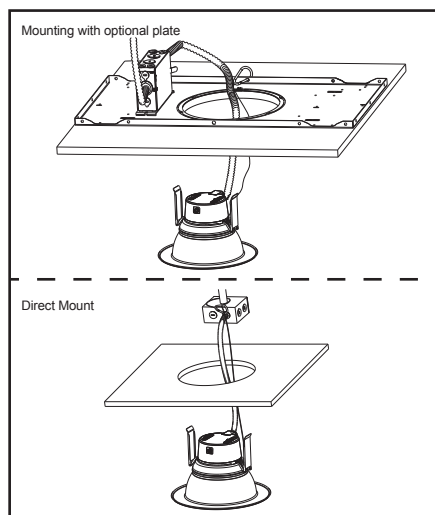
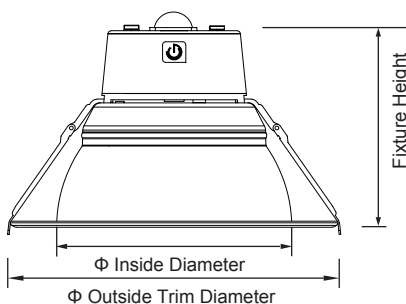

fig. 5



RETROFIT, DIRECT MOUNT AND NEW CONSTRUCTION INSTALLATION



Fixture	Inside Diameter	Outside Trim Diameter	Fixture Height	Minimum Cutout	Maximum Cutout
SLFT4	4-1/8"	5-15/16"	4-1/8"	4-1/8"	5-1/8"
SLFT6	6-1/16"	8-1/4"	4-15/16"	6-1/8"	7-1/2"
SLFT8	7-5/8"	10-1/4"	5-11/16"	7-11/16"	9-7/16"
SLFT9.5	8-5/8"	11-3/8"	6-3/16"	8-11/16"	10-9/16"

SLFT4 is compatible with most standard plates with aperture ranging from 4-1/8" to 5-1/8".
 SLFT6 is compatible with most standard plates with aperture ranging from 6-1/8" to 7-1/2".
 SLFT8 is compatible with most standard plates with aperture ranging from 7-11/16" to 9-7/16".
 SLFT9.5 is compatible with most standard plates with aperture ranging from 8-11/16" to 10-9/16".

SELECTFIT DUALDIM ACCESSORIES INSTALLATION

TRIM INSERT (for 4", 6" and 8", SLFTx/CL/TRIM) and
WALL WASH (for 4" and 6" models, SLFTx/WW/ACC)

1. Locate the retainer clips at the edge of the top of the trim insert or wall wash insert. Locate the locking channel at the edge of the optical diffuser.
2. Insert and push the trim or wall wash inside the fixture until it clicks into the lens and is securely fasten. All retainer clips should be locked in the diffuser locking channel, and trim insert should be flush with the downlight reflector and flange.
3. For wall wash direct the open side toward the wall you want to graze.

Note: Trim insert and wall wash accessories can not be used together.

TRIM INSERT

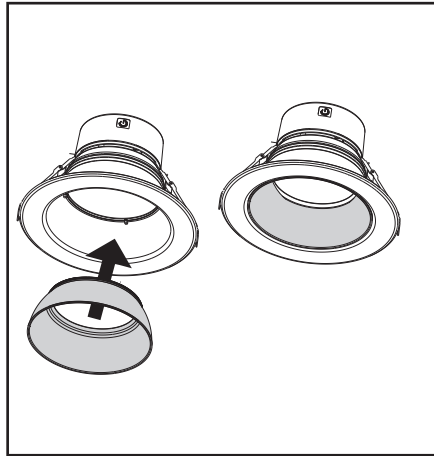

WALL WASH INSERT

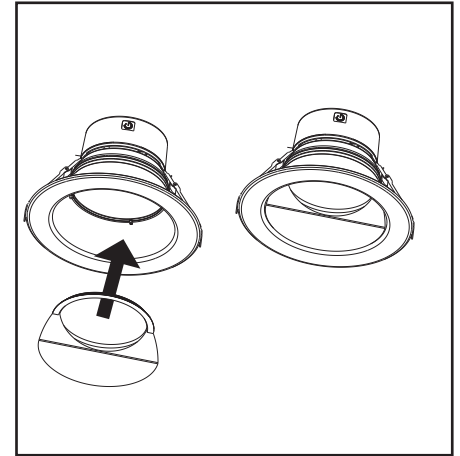

MEDIUM OPTIC (for 4", 6" and 8" models,
SLFTx/MD/OPTIC)

1. Detach the standard lens optic by rotating it counterclockwise, using the little grip holders if needed. Dispose the standard optical diffuser if not further needed.(fig. 1 & 2).
2. Once standard optic is removed, locate the retainers at the edge of the mixing chamber. Locate the hooking tab on the medium optics. (fig. 3).
3. Insert the lens in the downlight and turn clockwise to secure the lens with the mixing chamber, until it clicks and is firmly attached and secured. Flip the downlight facing downward to confirm the medium optic is secured. (fig. 4 & 5)

fig. 1

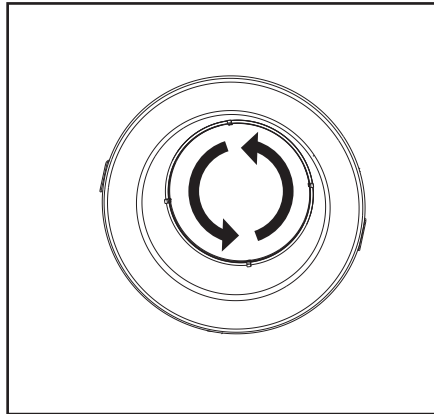

fig. 2

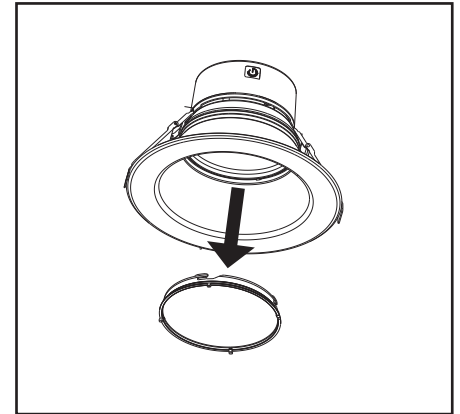

fig. 3

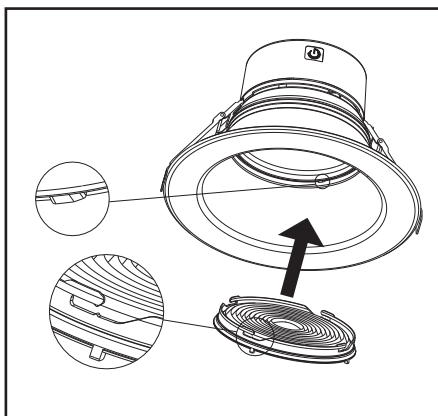

fig. 4

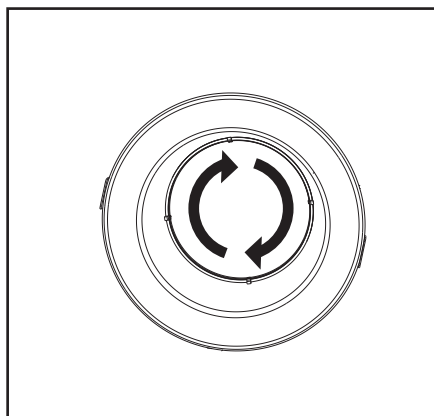

fig. 5

